

### APPLICAZIONI

Elettropompe centrifughe monogiranti adatte a coprire richieste di piccole, medie e grandi portate.

Utilizzo in impianti domestici, agricoli e industriali, distribuzione automatica dell'acqua per mezzo di piccoli serbatoi (autoclave), per irrigazione a pioggia e a scorrimento in giardino e agricoltura, per aumentare, in derivazione la pressione di rete degli acquedotti.

### APPLICATION

Single impeller centrifugal pumps suitable to cover any small, medium or large capacity request; for domestic, agricultural and industrial purposes; with automatic water distribution through small and medium sized tanks; for sprinkler and flood irrigation systems in gardening and agriculture; to increase in derivation system pressure in aqueducts.



GIRANTE - IMPELLER

### LIMITI D'IMPIEGO

- Temperatura liquido fino a 35°C (per un uso domestico secondo EN 60335-2-41)  
Temperatura max. liquido: 60°C (per altri impieghi)
- Temperatura ambiente fino a 40°C
- Altezza d'aspirazione manometrica fino a 7 mt.
- Servizio continuo
- Indice di efficienza minimo (BEP) MEI  $\geq 0,4$

### MOTORE

- Monofase 230V-50Hz
- Trifase 230/400V-50Hz
- Motore elettrico ad induzione a 2 poli ( $n = 2850 \text{ min}^{-1}$ )
- Isolamento Classe F
- Protezione IP 44

### MATERIALI

- |                     |                       |
|---------------------|-----------------------|
| - Corpo pompa       | Ghisa                 |
| - Supporto motore   | Ghisa                 |
| - Girante           | Acciaio Inox AISI 304 |
| - Albero motore     | Acciaio Inox AISI 304 |
| - Tenute meccaniche | Ceramica/Grafite/NBR  |

### OPERATING CONDITIONS

- Liquid temperature up to 35°C (for home use according to EN 60335-2-41)  
Temperature max. liquid: 60°C (for other uses)
- Ambient temperature up to 40°C
- Total suction lift up to 7 mt.
- Continuous duty
- Minimum efficiency index (BEP) MEI  $\geq 0,4$

### MOTOR

- Single-phase 230V-50Hz
- Three-phase 230/400V-50Hz
- Two-Pole induction motor ( $n = 2850 \text{ min}^{-1}$ )
- Insulation Class F
- Protection IP 44

### MATERIALS

- |                    |                          |
|--------------------|--------------------------|
| - Pump body        | Cast Iron                |
| - Motor support    | Cast Iron                |
| - Impeller         | Stainless Steel AISI 304 |
| - Shaft with rotor | Stainless Steel AISI 304 |
| - Mechanical seal  | Ceramic/Graphite/NBR     |

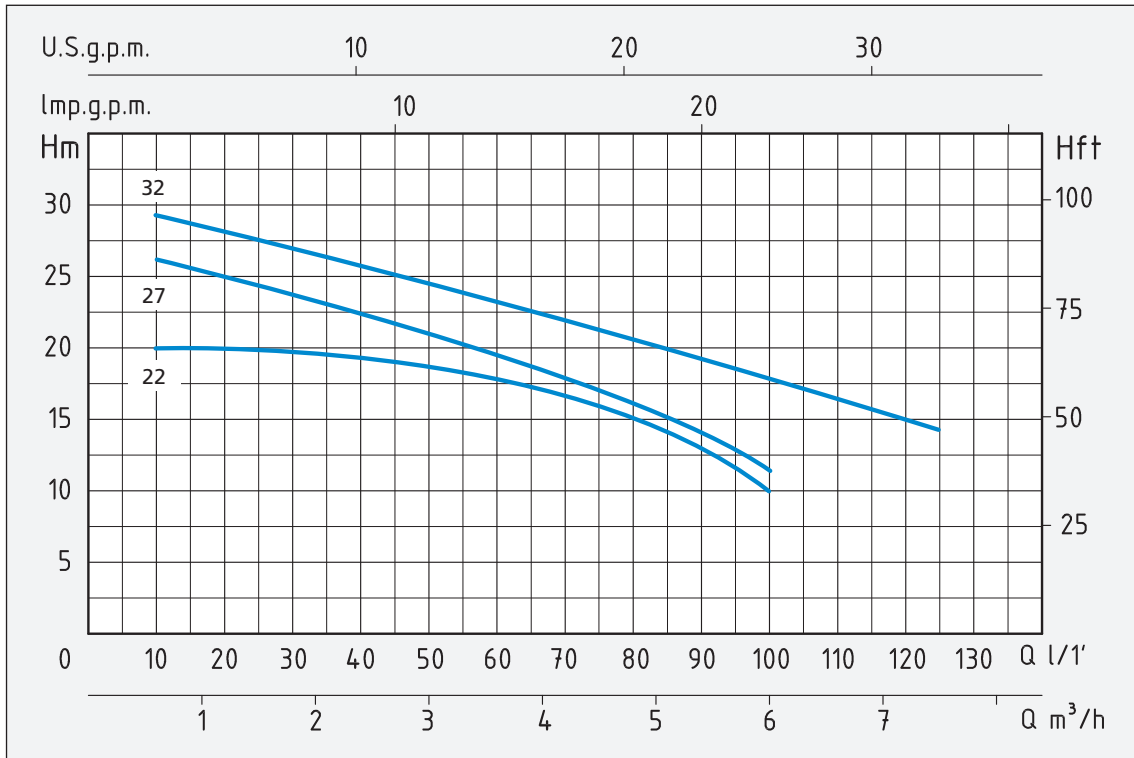

TIPO TYPE		POTENZA NOMINALE NOMINAL POWER		POTENZA ASSORBITA INPUT POWER	AMPERE		Q = PORTATA - CAPACITY							
Monofase Single-phase	Trifase Three-phase	P2		P1	Monofase Single-phase	Trifase Three-phase	m³/h	0,6	1,2	2,7	3,6	5,4	6	7,5
		HP	kW	kW			lt/1'	10	20	45	60	90	100	125
CM 22		0,5	0,37	0,65	2,8		Prevalenza manometrica totale in m.C.A. - Total head in meters w.c.							
CM 27		0,75	0,55	0,9	4		H (m)	20	18	17	16	12	10	
CM 32	C 32	1	0,75	1,2	5,5	2,3		27	25	20	18	14	12,5	
								29	28	26	23	20	18	14

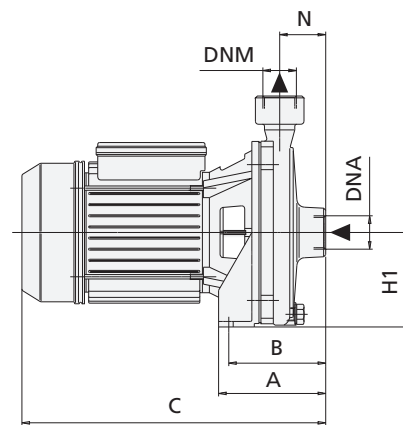
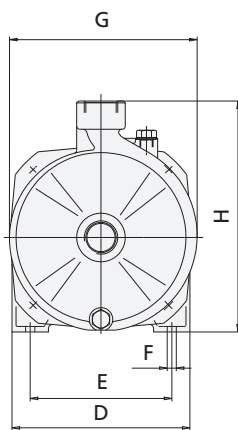

TIPO TYPE		DIMENSIONI mm - DIMENSIONS mm												DIMENSIONI DIMENSIONS mm			PESO WEIGHT
Monofase Single-phase	Trifase Three-phase	A	B	C	D	E	F	G	H	H1	N	DNA	DNM	P	L	H	Kg
CM 22		100	90	260	162	126	9	164	205	83	47	1"	1"	184	300	232	9,4
CM 27		108	98	300	176	140	9	186	229	94	50	1"	1"	206	348	257	9,4
CM 32	C 32	108	98	300	176	140	9	186	229	94	50	1"	1"	206	348	257	14,8